

Rechargeable Sealed Lead-Acid Battery

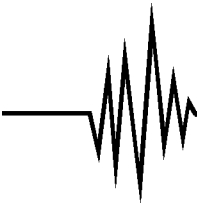

PS-1220

12 Volt 2.5 Amp. Hrs.



Features:

- Absorbent Glass Mat (AGM) technology for superior performance.
- Valve regulated, spill proof construction allows safe operation in any position.
- Power/volume ratio yielding unrivaled energy density.
- Rugged ABS plastic case and cover
- Approved for transport by air. D.O.T., I.A.T.A., F.A.A. and C.A.B. certified.
- U.L. recognized under file number MH 20845.



PERFORMANCE SPECIFICATIONS

| | |
|--|--|
| Nominal Voltage | 12 volts (6 cells in series) |
| Nominal Capacity | |
| 20 hour rate (125mA to 10.50 volts) | 2.50 A.H. |
| 10 hour rate (220mA to 10.50 volts) | 2.20 A.H. |
| 5 hour rate (400mA to 10.20 volts) | 2.00 A.H. |
| 1 hour rate (1500mA to 9.00 volts) | 1.50 A.H. |
| Approximate Weight | 2.20 pounds (1.00 kg) |
| Energy Density (20 hour rate) | 1.34 Watt-hours/cubic inch (80.3 Watt-hours/l) |
| Specific Energy (20 hour rate) | 13.6 Watt-hours/pound (30.0 Watt-hours/kg) |
| Internal Resistance (Fully Charged Battery) | 43 milliohms (approximately) |
| Maximum Discharge Current (≤ 7 Min.) | 7.5 amperes |
| Maximum Short-Duration Discharge Current (≤ 10 Sec.) | 25.0 amperes |
| Terminals | “F1”:: Quick disconnect tabs, 0.187" x 0.032"- Mate with AMP. INC. FASTON “187” series |
| Shelf Life — % of nominal capacity at 68° F (20° C) | |
| 1 Month..... | 97% |
| 3 Months..... | 91% |
| 6 Months..... | 83% |
| Operating Temperature Range | |
| Charge | -4°F (-20°C) to 122°F (50°C) |
| Discharge | -4°F (-20°C) to 140°F (60°C) |
| Case | ABS Plastic |

Shelf Life and Storage

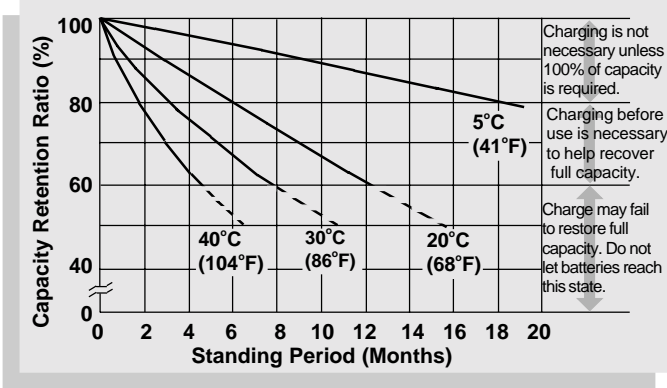

Discharge Characteristics

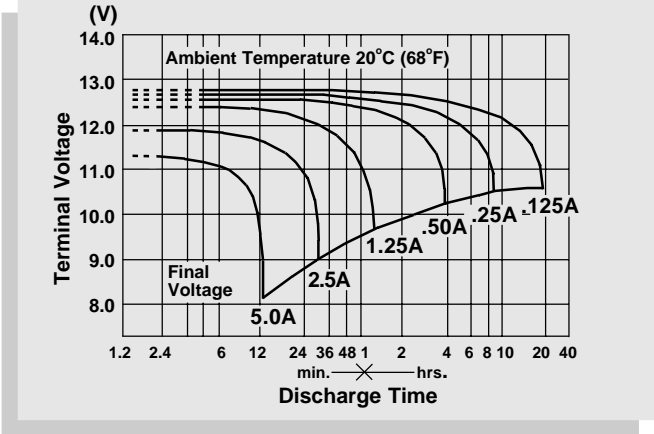

Life Characteristics in Stand-By Use

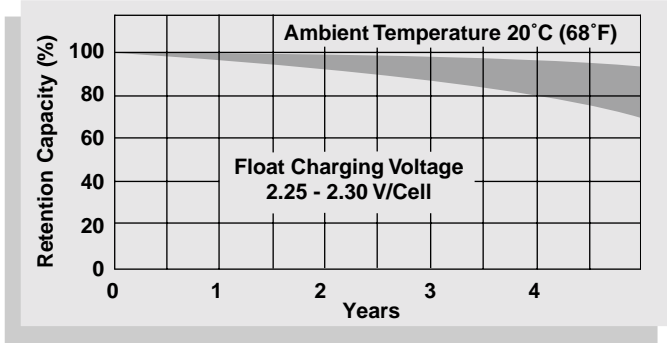

Discharge Time vs. Discharge Current

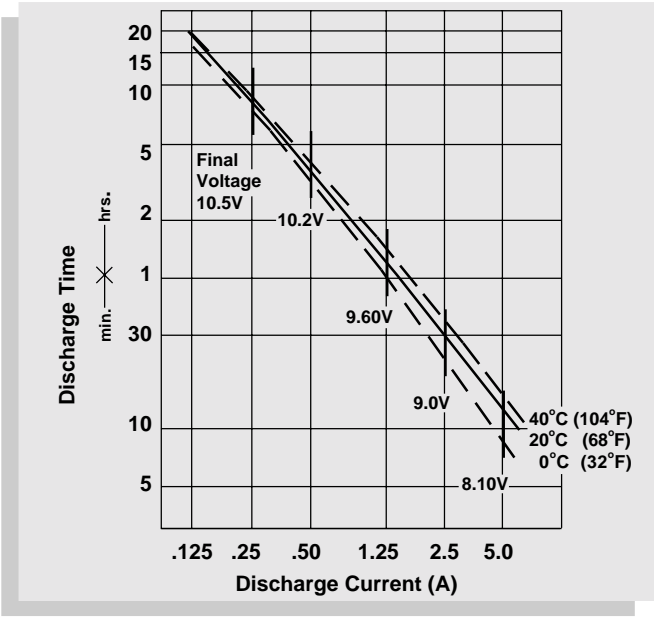

Life Characteristics in Cyclic Use

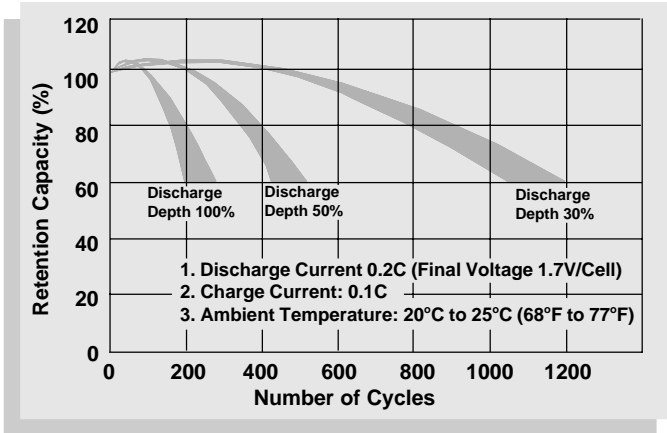

Physical Dimensions: in. (mm)

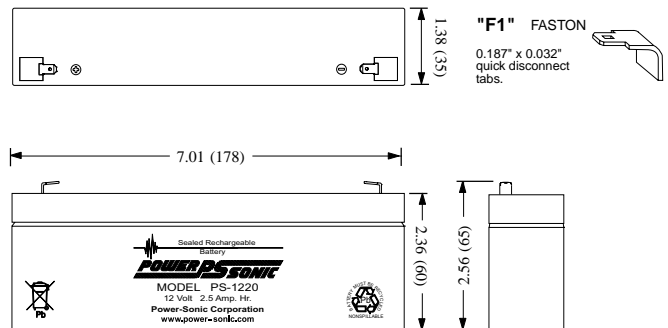

Tolerances are +/- 0.04 in. (+/- 1mm) and +/- 0.08 in. (+/- 2mm) for height dimensions. All data subject to change without notice.

CHARGING

Cycle Applications: Limit initial current to 750mA. Charge until battery voltage (under charge) reaches 14.40 to 14.70 volts at 68°F (20°C). Hold at 14.40 to 14.70 volts until current drops to approximately 25mA. Battery is fully charged under these conditions, and charger should either be disconnected or switched to "float" voltage.

"Float" or "Stand-By" Service: Hold battery across constant voltage source of 13.50 to 13.80 volts continuously. When held at this voltage, the battery will seek its own current level and maintain itself in a fully charged condition.

NOTE: Due to the self-discharge characteristics of this type of battery, it is imperative that they be charged after 6-9 months of storage, otherwise permanent loss of capacity might occur as a result of sulfation.



SALES & MARKETING
 3106 Spring Street
 Redwood City, CA 94063 USA
 Tel: 650-364-5001 Fax: 650-366-3662
 national-sales@power-sonic.com



ISO9001-2000
 FM39170

www.power-sonic.com

CUSTOMER SERVICE
 7550 Panasonic Way
 San Diego, CA 92154 USA
 Tel: 619-661-2030 Fax: 619-661-3648
 customer-service@power-sonic.com