

Rechargeable Sealed Lead-Acid Battery

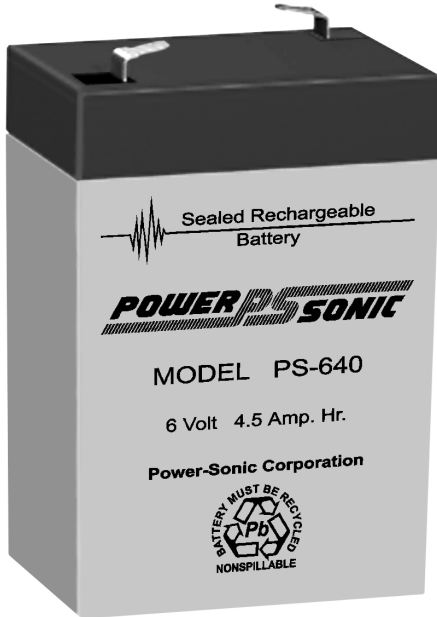

PS-640
6 Volt 4.5 Amp. Hrs.

Features:

- Absorbent Glass Mat (AGM) technology for superior performance.
- Valve regulated, spill-proof construction.
- Power/volume ratio yielding unrivaled energy density.
- Rugged, impact resistant case and cover.
- Approved for transport by air. D.O.T., I.A.T.A., F.A.A. and C.A.B. certified.
- U.L. recognized under file number MH 14328.



PERFORMANCE SPECIFICATIONS

Nominal Voltage	6 volts (3 cells in series)
Nominal Capacity	
20 hour rate (225mA to 5.25 volts).....	4.5 A.H.
10 hour rate (400mA to 5.25 volts).....	4.0 A.H.
5 hour rate (700mA to 5.10 volts).....	3.5 A.H.
1 hour rate (2700mA to 4.50 volts).....	2.7 A.H.
Approximate Weight	1.95 pounds (0.90 kg)
Energy Density (20 hour rate)	1.29 Watt-hours/cubic inch (78.8 Watt-hours/l)
Specific Energy (20 hour rate)	13.8 Watt-hours/pound (30.0 Watt-hours/kg)
Internal Resistance (Fully Charged Battery)	20 milliohms (approximately)
Maximum Discharge Current (5 Min.)	13.5 amperes
Maximum Short-Duration Discharge Current (5 Sec.)	45 amperes
Terminals	640 F: Quick disconnect tabs, 0.187" x 0.032"- Mate with AMP. INC. FASTON "187" series 640 WL: Leads terminated with free hanging AMP. INC. MATE-N-LOK connector. Socket housing 1-480318-0 mates with pin housing 1-480319-0
Vibration Test (2000 cycles/minute, 0.10 inch excursion, 2 hours)	No loss in capacity or performance
Shelf Life — % of nominal capacity at 68° F (20° C)	
1 Month.....	97%
3 Months.....	91%
6 Months.....	83%
Operating Temperature Range	
Charge	-4°F (-20°C) to 122°F (50°C)
Discharge	-4°F (-20°C) to 140°F (60°C)
Case	High-Impact Polystyrene

Shelf Life and Storage

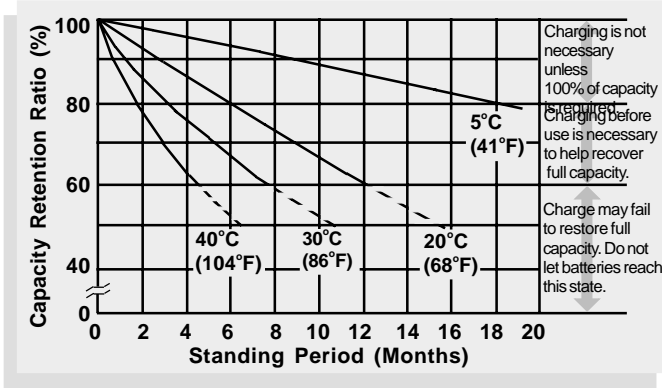

Discharge Characteristics

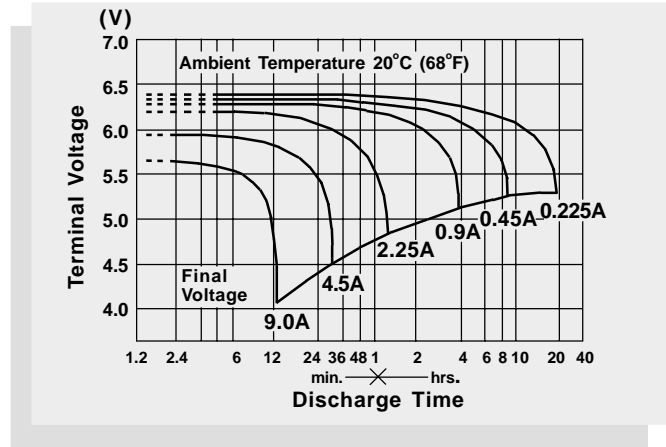

Life Characteristics in Stand-By Use

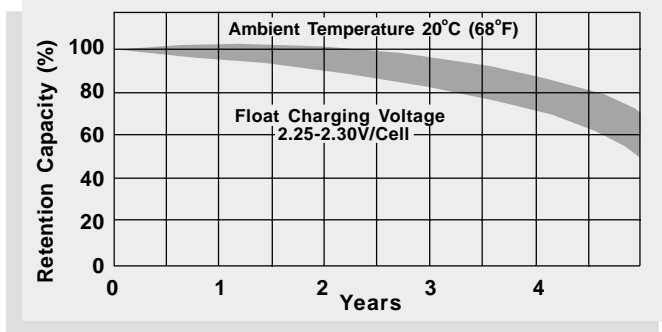

Discharge Time vs. Discharge Current

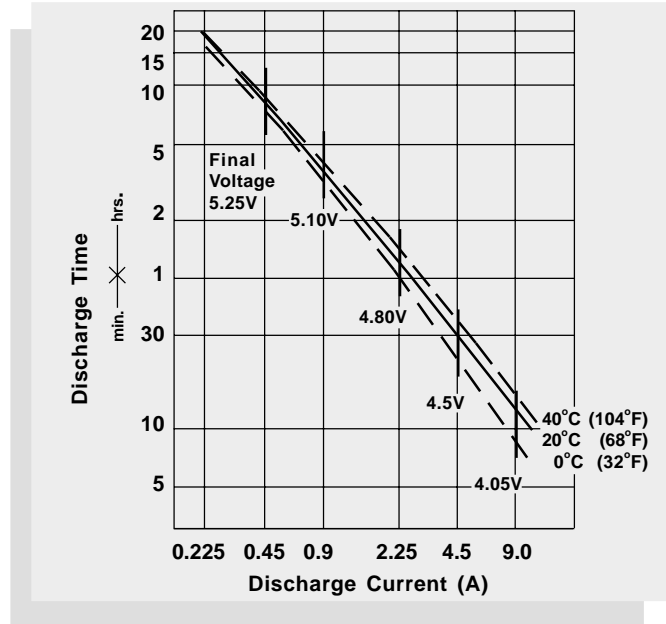

Life Characteristics in Cyclic Use

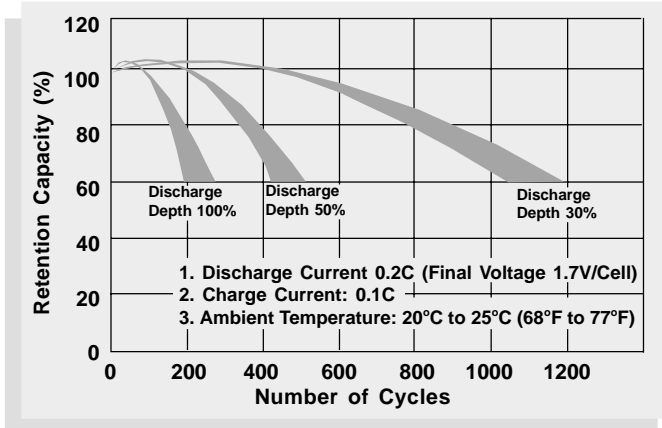

CHARGING

Cycle Applications: Limit initial current to 900mA. Charge until battery voltage (under charge) reaches 7.20 to 7.35 volts at 68°F (20°C). Hold at 7.20 to 7.35 volts until current drops to approximately 45mA. Battery is fully charged under these conditions, and charger should either be disconnected or switched to "float" voltage.

"Float" or "Stand-By" Service: Hold battery across constant voltage source of 6.75 to 6.90 volts continuously. When held at this voltage, the battery will seek its own current level and maintain itself in a fully charged condition.

NOTE: Due to the self-discharge characteristics of this type of battery, it is imperative that they be charged after 6-9 months of storage, otherwise permanent loss of capacity might occur as a result of sulfation.

Physical Dimensions

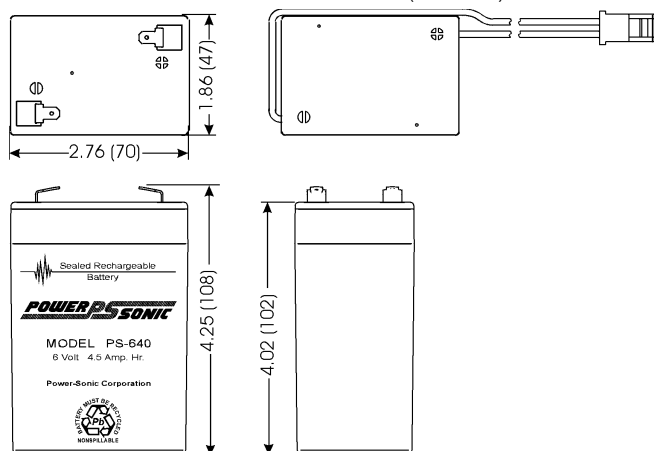

Tolerances are +/- 0.04 in. (+/- 1mm) and +/- 0.08 in. (+/- 2mm) for height dimensions. All data subject to change without notice.



SALES & MARKETING
 3106 Spring Street
 Redwood City, CA 94063 USA
 Tel: 650-364-5001 Fax: 650-366-3662
 national-sales@power-sonic.com



www.power-sonic.com

ISO9002
 FM39170
 FM39171

CUSTOMER SERVICE
 9163 Siempre Viva Road
 San Diego, CA 92154 USA
 Tel: 619-661-2030 Fax: 619-661-3648
 battery@power-sonic.com